



mythos









MY22M 0101.090



H = mm 2200 • L = mm 900

MY22M 0102.090



H = mm 2200 • L = mm 900

MY22M 0103.090



H = mm 2200 • L = mm 900

MY22M 0801.090



H = mm 2200 • L = mm 90

MY22M 0204.090



H = mm 2200 • L = mm 900

MY22M 0205.090



H = mm 2200 • L = mm 900

MY22M 0204V.090



H = mm 2200 • L = mm 900

MY22M 0205V.090



H = mm 2200 • L = mm 900

MG 12 0202.090



H = mm 1400 • L = mm 900

MG 12 0203.090



H = mm 1400 • L = mm 900

MG 12 0101.090



H = mm 1400 • L = mm 900

MG 12 0102.090



H = mm 1400 • L = mm 900





MT 03

MY22M 0102.090

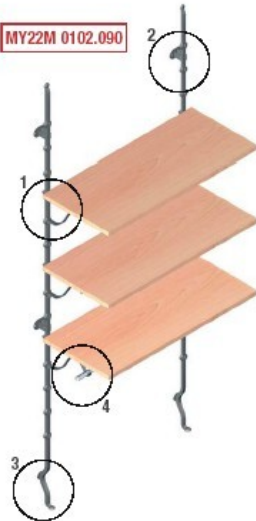

MT 02

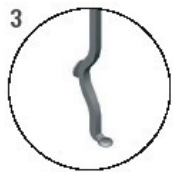

MT 220

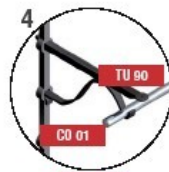

TU 90
CO 01
MT 06

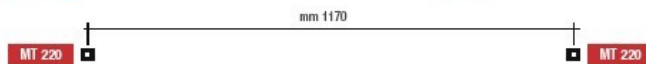
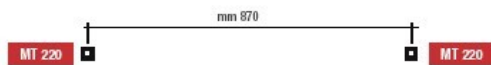
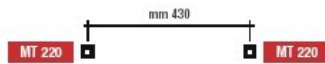

CR
Cromato
Chrome
Chromé
Verchromt



MT 220		
mm	a=200 b=36	
Kg	5,50	
	2	
	VP+VA	

MT 03		
mm	a=125 b=16 c=300	
Kg	0,86	
	14	
	VP+VA	

CO 01		
mm	d=25	
Kg	0,01	
	100	
	CR+VP+VA	

MT 07		
mm	a=125 b=16 c=420	
Kg	0,94	
	18	
	VP+VA	

MT 02		
mm	a=60 b=57 c=50	
Kg	0,07	
	48	
	VP+VA	

MT 06		
mm	a=125 b=16 c=300	
Kg	0,93	
	14	
	VP+VA	

TU 46		TU 90		TU 120		
mm	b=460 d=25	b=900 d=25	b=1200 d=25			
Kg	0,32	0,63	0,84			
	10	10	10			
	CR+VP+VA	CR+VP+VA	CR+VP+VA			



VP Verchromt/Painted
Verlackt

021 • ral 9005	
Nero goffrato	
Black	
Noir laqué	
Schwarz	

VA Verchromt/Painted
Verlackt

125		130		140		150		165	
Craie Osaka		Rosso Thai		Rouge Thai		Bleu Ball		Verte male	
Osaka grey		Thai red		Thai red		Ball blue		Male green	
Osaka-grau		Thai-rot		Kupfer		Ball-blau		Vert-grün	



mm	b=430	
Kg	1,50	
	1	
	VP-VA	

MT 220

mm	b=870	
Kg	2,50	
	1	
	VP-VA	

MT 220

mm	b=1170	
Kg	3,00	
	1	
	VP-VA	

MT 220

mm	a=1800 b=920 c=500	
Kg	19,00	
	1	
	VP-VA	

MG 20.090

mm	a=1380 b=230	
Kg	4,00	
	1	
	VP-VA	

MG 80

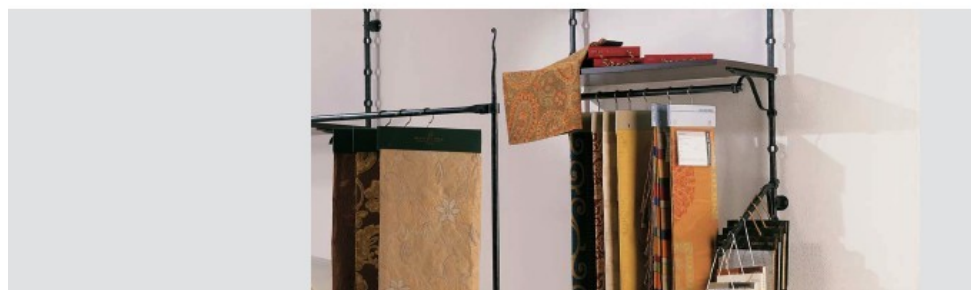

VP Vernickelt/Painted
Ver nickeliert

021 • ral 9005	
Nero goffrato	
Black	
Noire laqué	
Schwarz	

VA Vernickelt/Painted
Ver nickeliert

125		130		140		150		165	
Grigio Oseka		Rosso thal		Rame		Blue Ball		Verde maki	
Oseka grey		Thal red		Copper		Ball blue		Maki green	
Cra Oseka		Rouge thal		Kupfer		Ball-bleu		Vert maki	
Oseka-grau		Thal-rot						Maki-grün	



MG 12



MT 03



MG12 0102



MG 12



CR
Cromato
Chrome
Chromé
Verchromt



mm	a=1400 b=900 c=788
Kg	24,00
	1
	VP+VA

MG 12

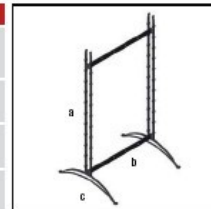

mm	b=460 Ø=25	b=900 Ø=25	b=1200 Ø=25
Kg	0,32	0,63	0,84
	10	10	10
	CR+VP+VA	CR+VP+VA	CR+VP+VA

TU 46

TU 90

TU 120

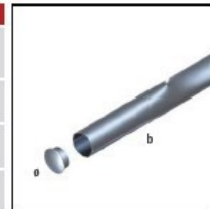

mm	a=125 b=16 c=300
Kg	0,86
	14
	VP+VA

MT 03

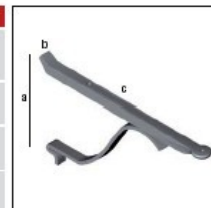

mm	a=125 b=16 c=300
Kg	0,93
	14
	VP+VA

MT 06

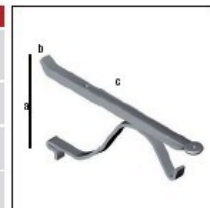

mm	Ø=25
Kg	0,01
	100
	CR+VP+VA

CO 01

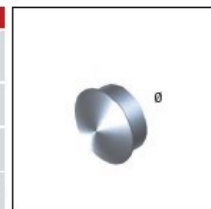

mm	a=125 b=16 c=420
Kg	0,94
	18
	VP+VA

MT 07

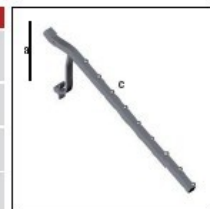

VP Verchromt/Painted
Verl.Alackiert

021 - ral 9005
Nero gommato
Black
Nero Gomme
Schwarz

VA Verchromt/Painted
Verl.Alackiert

125
Grigio Osaka
Osaka grey
Grise Osaka
Osaka-grau

130
Rosso thai
Thai red
Rouge-thai
Thai-red

140
Rame
Copper
Cuivre
Kupfer

150
Bleu Ball
Ball blue
Bleu Ball
Ball-blau

165
Verde maki
Maki green
Vert maki
Maki-grün

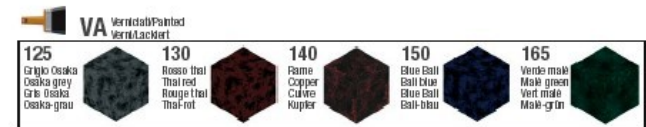
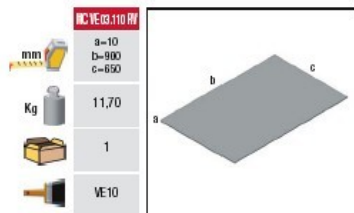
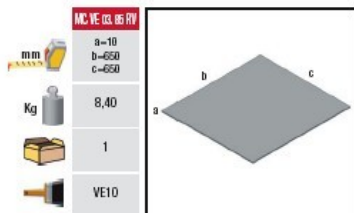
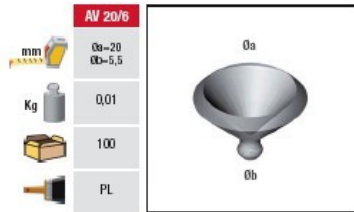
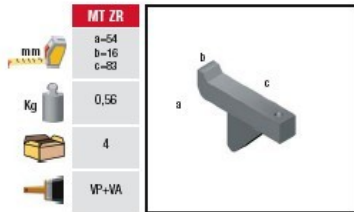
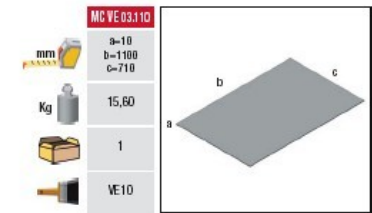
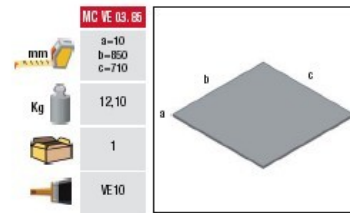
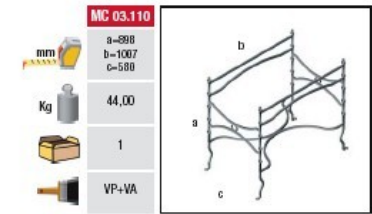
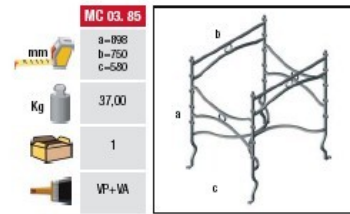
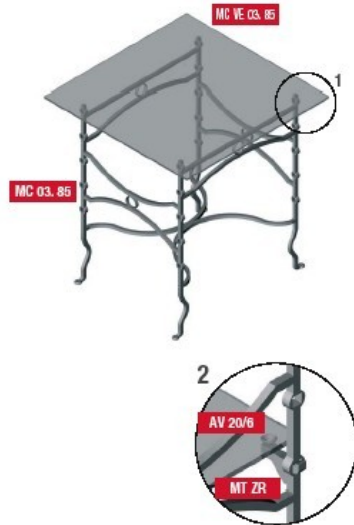
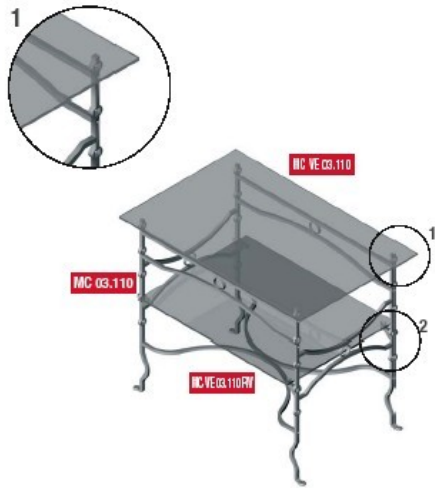

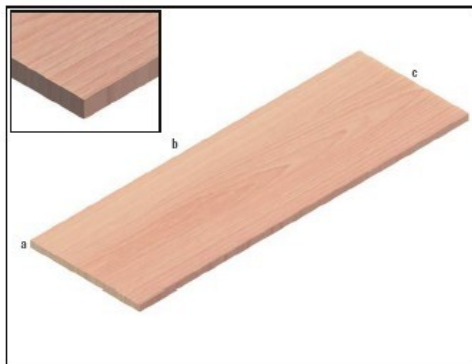

	mm	Kg		
RQ 46.3	a=22 b=460 c=300	2,20	40	LA
RQ 46.4	a=22 b=460 c=400	2,90	40	LA
RQ 46.5	a=22 b=460 c=500	3,20	40	LA
RQ 90.3	a=22 b=900 c=300	4,10	40	LA
RQ 90.4	a=22 b=900 c=400	5,75	40	LA
RQ 90.5	a=22 b=900 c=500	6,50	40	LA
RQ120.3	a=22 b=1200 c=300	5,27	40	LA
RQ120.4	a=22 b=1200 c=400	7,40	40	LA
RQ120.5	a=22 b=1200 c=500	8,75	40	LA

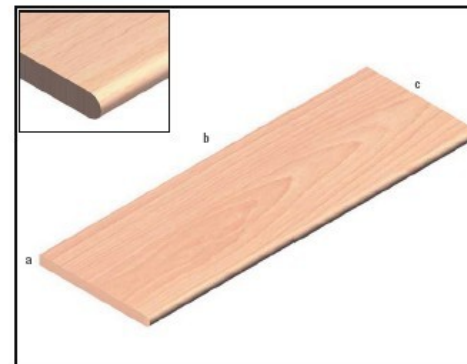

	mm	Kg		
RP 46.3	a=25 b=460 c=300	2,50	40	LS
RP 46.4	a=25 b=460 c=400	3,00	40	LS
RP 46.5	a=25 b=460 c=500	3,50	40	LS
RP 90.3	a=25 b=900 c=300	4,50	40	LS
RP 90.4	a=25 b=900 c=400	6,30	40	LS
RP 90.5	a=25 b=900 c=500	6,90	40	LS
RP120.3	a=25 b=1200 c=300	5,92	40	LS
RP120.4	a=25 b=1200 c=400	8,16	40	LS
RP120.5	a=25 b=1200 c=500	10,50	40	LS

LA Pannello melaminico/Melamine panel/Melamine panneau/Melamin panel



LS Pannello Soft-forming/Soft-forming panel/Soft-forming panneau/Soft-forming panel

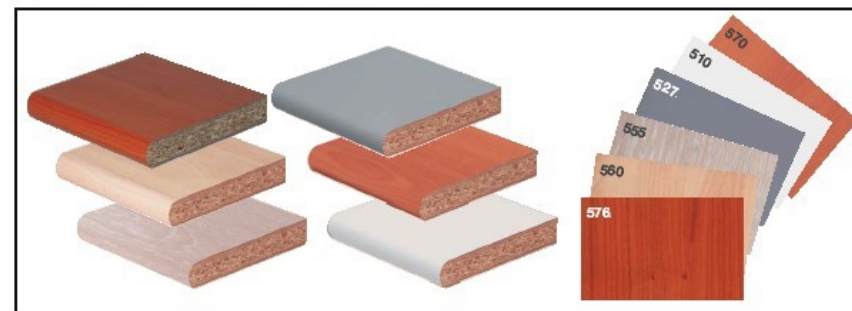



MT 02

MY22M 0101V.090

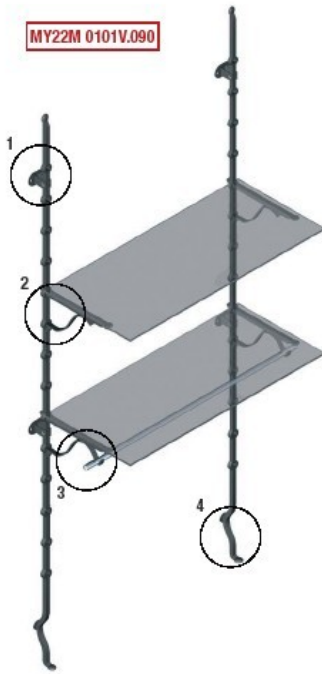

MT 03



MT 06



MT 220

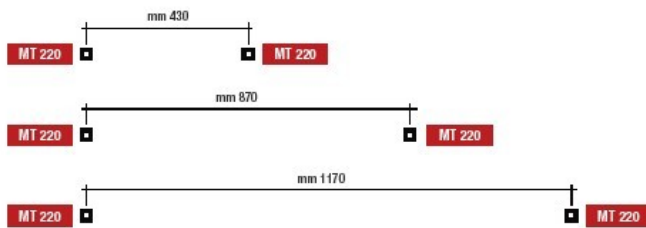

MT 03

mm	Kg		
a=125 b=16 c=300	0,86	14	VP+VA

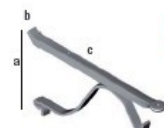

MT 06

mm	Kg		
a=125 b=16 c=300	0,93	14	VP+VA



AV 20/6

mm	Kg		
0a=20 0b=5,5	0,01	100	PL

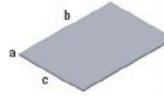

RV8

mm	Kg		
a=b c=320	2,90	1	VE8
a=b c=400	3,70	1	VE8
a=b c=320	5,76	1	VE8
a=b c=400	7,20	1	VE8
a=b c=320	7,68	1	VE8
a=b c=400	9,60	1	VE8



VE
Vetro
Glas
Verre
Glas



VP Verniciato/Painted
Vernis/Lackiert



VA Verniciato/Painted
Vernis/Lackiert

021 • ral 9005 Nero goffrato Black Noir sombre Schwarz	125 Grigio Osaka Osaka grey Grise Osaka Osaka-grau	130 Rosso thal Thal red Rouge Thal Thal-rot	140 Rame Copper Kupfer	150 Blue Ball Ball blue Blue Ball Ball-blau	165 Verde malè Malè green Vert malè Malè-grün
--	--	---	---------------------------------	---	---



	MT 37	a=38 b=65 c=60	0,30	14	VP+VA	
	T0240 T0272 T0300	a=30 b=2400 c=15 a=30 b=2400 c=15 a=30 b=2720 c=15 a=30 b=3000 c=15	1,74 1,74 2,33 2,57	10 10 10 10	CR NS NS CR	
	CD 3015 CD 3015	a=30 c=15 a=30 c=15	0,01 0,01	100 100	CR NS	
	AS 72 AS 72	b=50 c=61 b=50 c=61	1,15 1,15	100 100	CR NS	
	OS 32 OS 32	c=242 Ø=138 c=242 Ø=138	0,15 0,15	50 50	CR NS	

VP Verniciato/Painted
Verni/Lackiert

021 • ral 9005
Nero goffrato
Black
Nero Gauhé
Schwarz

VA Verniciato/Painted
Verni/Lackiert

125 Grigio Osaka Osaka grey Gris Osaka Osaka-grau	130 Rosso thal Thal red Rouge thal Thal-rot	140 Rame Copper Cuivre Kupfer	150 Blue Est Est blue Bla-Ést Est-blau	165 Verde male Male green Vert male Male-grün
--	--	--	---	--

CR
Cromato
Chrome
Verchromt

NS
Nichel satinato
Satin
Satin
Matt nickel



	mm	Kg		
OS 46	c=100 Ø=6	0,05	100	CR
OS 46	c=100 Ø=6	0,05	100	NS

max 0,6 kg



	mm	Kg		
OS 47	c=150 Ø=6	0,07	100	CR
OS 47	c=150 Ø=6	0,07	100	NS

max 0,7 kg



	mm	Kg		
OS 48	c=200 Ø=6	0,08	100	CR
OS 48	c=200 Ø=6	0,08	100	NS

max 0,8 kg



	mm	Kg		
OS 49	c=300 Ø=6	0,10	100	CR
OS 49	c=300 Ø=6	0,10	100	NS

max 1 kg



	mm	Kg		
OS 420	b=150 c=300	0,44	25	CR
OS 420	b=150 c=300	0,44	25	NS



	mm	Kg		
OS 430	c=400	0,38	25	CR
OS 430	c=400	0,38	25	NS

 **CR**
 Cromato
 Chrome
 Chromé
 Verchromt

 **NS**
 Nichel satinato
 Satin
 Satinée
 Mattnickel



	mm	Kg		
OS 440	c=300	0,32	25	CR
OS 440	c=300	0,32	25	NS



	mm	Kg		
OS 62	a=150 c=420	0,51	20	CR
OS 62	a=150 c=420	0,51	20	NS



	mm	Kg		
OS 63	a=200 c=400	0,50	20	CR
OS 63	a=200 c=400	0,50	20	NS



	mm	Kg		
OS 64	a=200 c=380	0,57	20	CR
OS 64	a=200 c=380	0,57	20	NS



	mm	Kg		
OS 72	c=300 Ø=32	0,25	25	CR
OS 72	c=300 Ø=32	0,25	25	NS



	mm	Kg		
OS 76	c=250	0,16	25	CR
OS 76	c=250	0,16	25	NS

 **CR**
 Cromato
 Chrome
 Chromé
 Verchromt

 **NS**
 Nichel satinato
 Satin
 Satinée
 Mattnickel



MY22M 0801.090

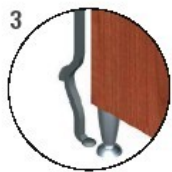

MT 44

mm	a=680 b=400 c=400
Kg	27,00
	1
	LA

MT 92

mm	a=680 b=400 c=400
Kg	25,50
	1
	LA

MT 92L

mm	a=680 b=900 c=400
Kg	33,40
	1
	LA

MT 92V

mm	a=680 b=900 c=400
Kg	35,30
	1
	LA

MT 94

mm	a=680 b=900 c=400
Kg	44,60
	1
	LA

PD 13

mm	a=130 b=50
Kg	0,10
	1
	CR

LA Pannelo melaminico
Melamine panel
Melamine paneles
Melamin panel

CR Cromato
Chrome
Chromé
Verchromt

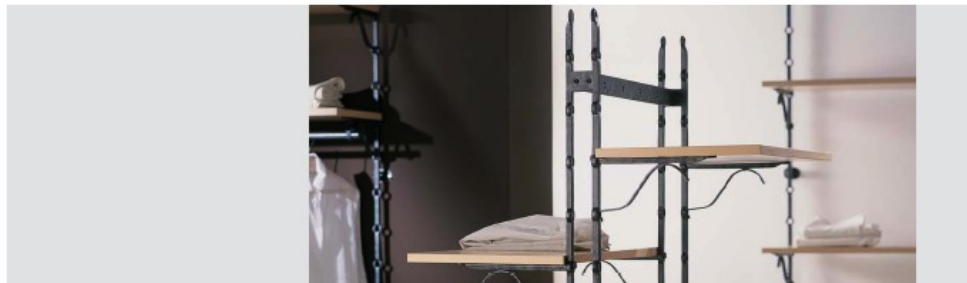

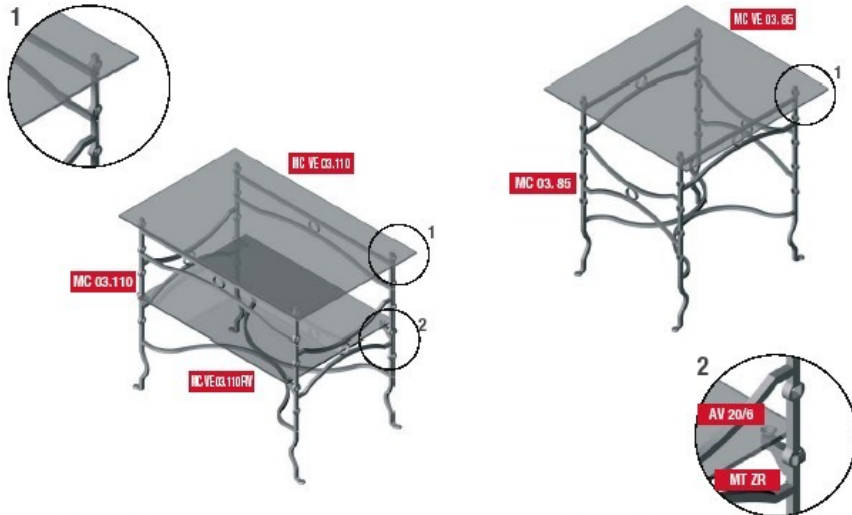

mm	a=54 b=16 c=83	
Kg	0,56	
	4	
	VP+VA	

mm	Øa=20 Øb=5,5	
Kg	0,01	
	100	
	PL	

mm	a=10 b=650 c=650	
Kg	8,40	
	1	
	VE10	

mm	a=10 b=690 c=690	
Kg	11,70	
	1	
	VE10	

PL		VE	
Plastica		Vetro	
Plastic		Vetro	
Plastique		Vetro	
Kunststoff		Vetro	

mm	a=898 b=750 c=580	
Kg	37,00	
	1	
	VP+VA	

mm	a=898 b=1007 c=580	
Kg	44,00	
	1	
	VP+VA	

mm	a=10 b=650 c=710	
Kg	12,10	
	1	
	VE10	

mm	a=10 b=1100 c=710	
Kg	15,60	
	1	
	VE10	



VP	Verlakt/Painted Verlacksiert	
021	• ral 9005	
Nero	goffrato	
Black		
Noire	caoué	
Schwarz		

VA	Verlakt/Painted Verlacksiert	
125	Ciniglia Osaka	
Osaka grey		
Osaka-grau		
130	Rosso Thal	
Thal red		
Rouge Thal		
Thal-rot		
140	Rame	
Copper		
Cuivre		
Kupfer		
150	Blue Ball	
Ball blue		
Blue Ball		
Ball-bleu		
165	Verde male	
Male green		
Vert male		
Male-grün		